

PrimeTest 200

Operating Instructions

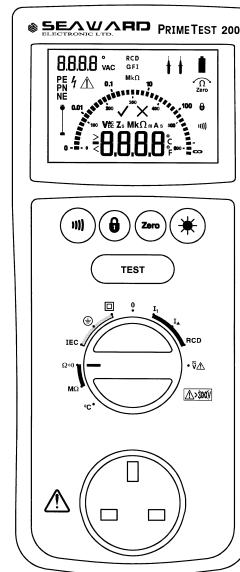

Bracken Hill, South West Industrial Estate,
 Peterlee, Co. Durham SR8 2SW. England.
 Tel: +44 (0)191-586 3511 Fax: +44 (0)191-586 0227
www.seaward.co.uk
sales@seaward.co.uk
calibration@seaward.co.uk

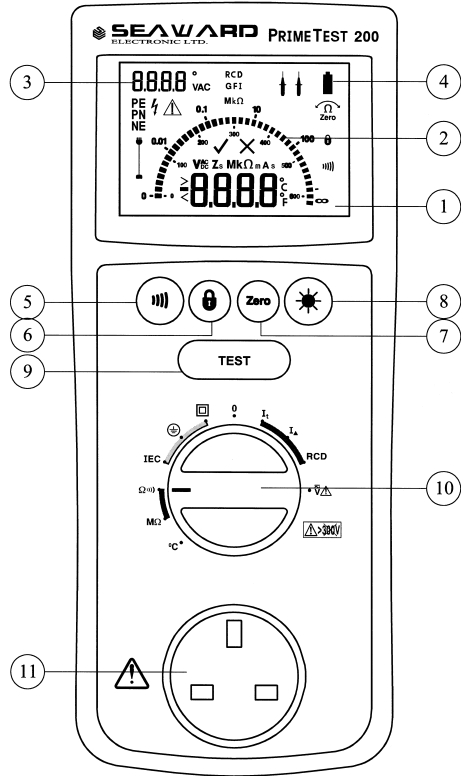

Fig 1.

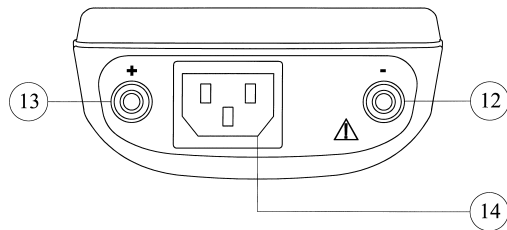

Fig 2.

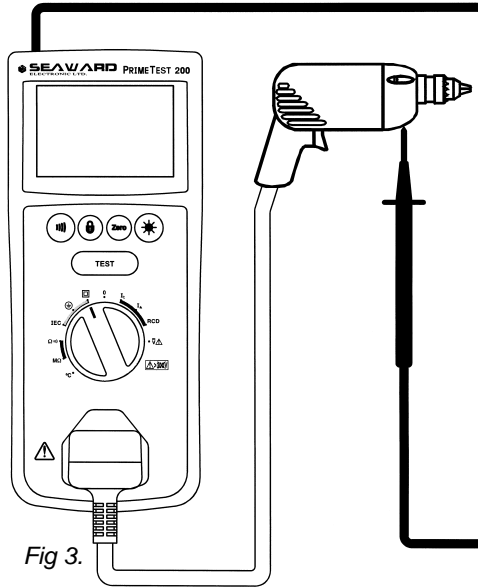

Fig 3.

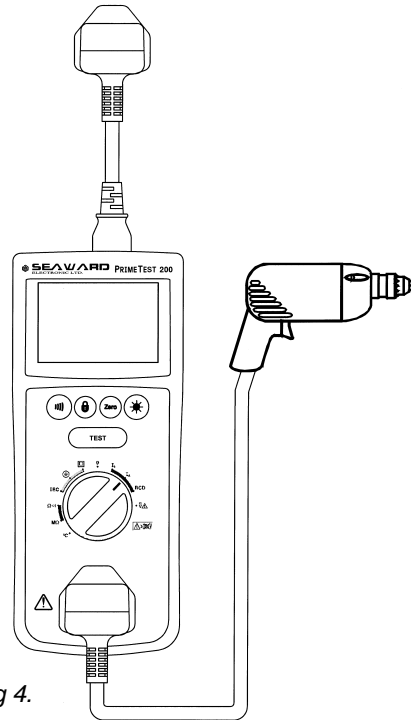

Fig 4.

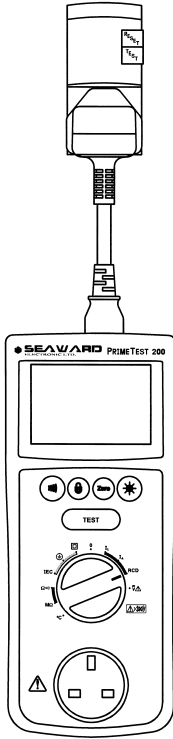

Fig 5.

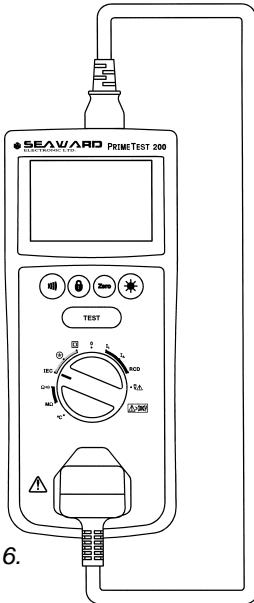

Fig 6.

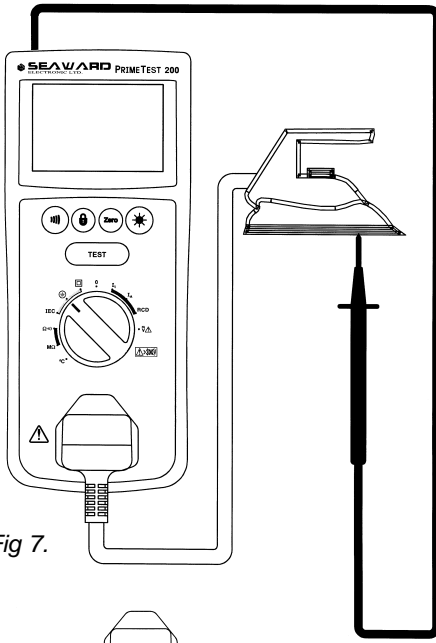

Fig 7.

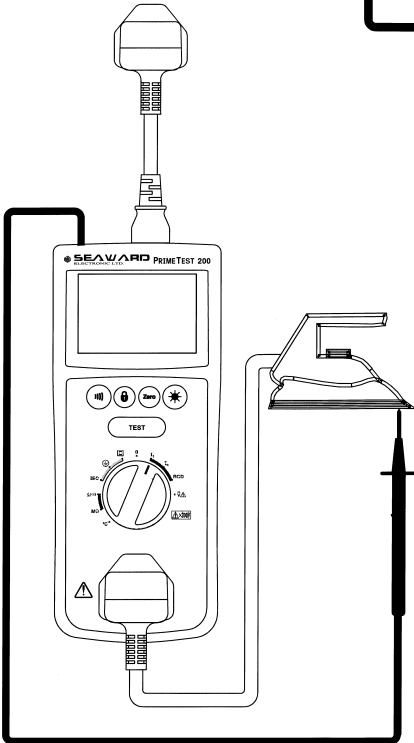

Fig 8.

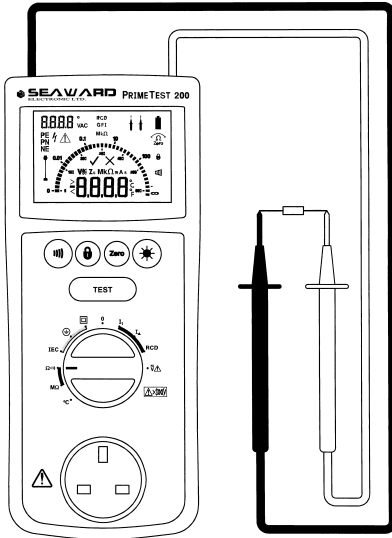

Fig 9.

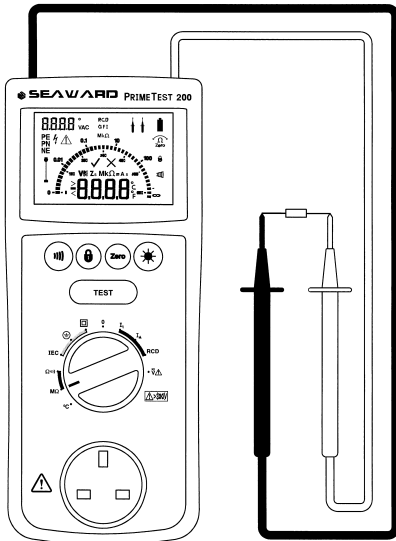

Fig 10.

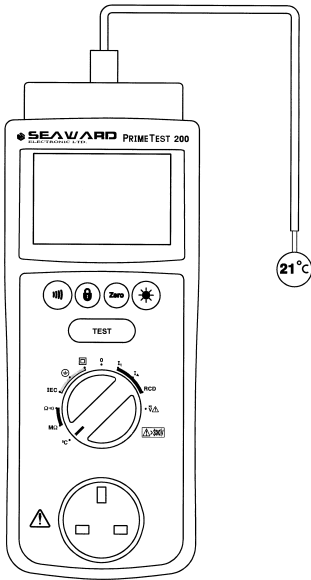

Fig 11

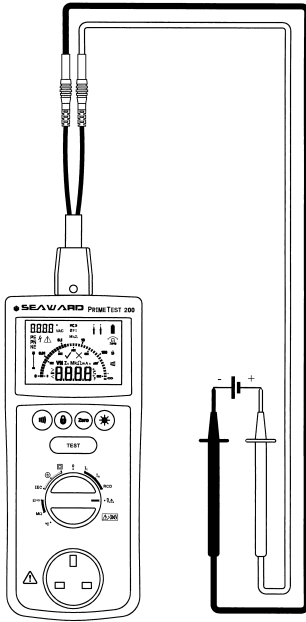

Fig 12A.

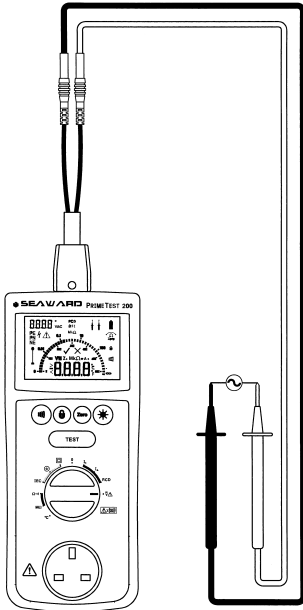
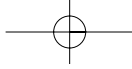
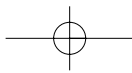
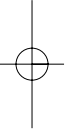

Fig 12B.



PrimeTest 200

Operating Instructions



Limited Warranty & Limitation of Liability

SEAWARD Electronic Limited guarantees this product for a period of 1 year. The period of warranty will be effective at the day of delivery.

(c) Copyright 2003

All rights reserved. Nothing from this edition may be multiplied, or made public in any form or manner, either electronically, mechanically, by photocopying, recording, or in any manner, without prior written consent from SEAWARD Electronic Limited. This also applies to accompanying drawings and diagrams.

Due to a policy of continuous development SEAWARD Electronic Limited reserves the right to alter the equipment specification and description outlined in this publication without prior notice and no part of this publication shall be deemed to be part of any contract for the equipment unless specifically referred to as an inclusion within such contract.

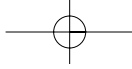

PrimeTest 200

Operating Instructions

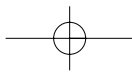
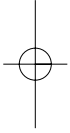
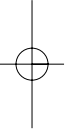

**Operating Instructions
PrimeTest 200**

A multifunction testing instrument: used to perform comprehensive electrical safety tests on:

- Class I appliances
- Class II appliances
- IEC Leads

With the PrimeTest 200 connected to the mains supply using an IEC mains lead the following tests can be performed:

- Differential current
- Touch current
- RCD
- Earth loop resistance
- Power socket wiring check

Additional diagnostic measurements can be performed:

- Insulation resistance measurements
- Resistance measurements
- Continuity testing
- AC/DC voltage measurements
- Temperature measurements

Contents

- 1. User Notes**
- 2. Safety Notes**
- 3. Standard Accessories**
- 4. Description**
- 5. General Information**
- 6. Environmental conditions**
- 7. Electrical Specifications**
- 8. Operation of Test Functions**
- 9. Maintenance**

1.0 User Notes

These operating instructions are intended for the use of adequately trained personnel.

The PrimeTest 200 has been designed to make measurements in a dry environment. It must not be used for making measurements in electric circuits with nominal voltage greater than 300 V AC/DC.

The following symbols are used in these operating instructions and on the PrimeTest 200.



Warning of electrical danger!

Indicates instructions must be followed to avoid danger to persons.



Important, follow the documentation! This symbol indicates that the operating instructions must be adhered to in order to avoid danger.



This symbol on the PrimeTest 200 indicates that the unit can safety test Class II equipment. The PrimeTest 200 is not double insulated.



(DC) direct current or (AC) alternating current.



This symbol on the PrimeTest 200 indicates that the unit can safety test Class I equipment.



This symbol on the PrimeTest 200 indicates the built in fuses.

2.0 Safety Notes

This PrimeTest 200 has been built and tested in accordance with:

DIN VDE 0404 part 1 and 2.

BS EN 61010 part 1.

BS EN 61557 part 1, 2, 4 and 10.

The PrimeTest 200 has left the factory in a perfectly safe state. To maintain this state and ensure safe operation of the unit, all notes and warnings in these instructions must be observed at all times.



This instrument may be used on electric circuits, which comply to over voltage category II. The PrimeTest 200 monitors the input voltage and will display a warning symbol. ⚡ on the display if a 30 V AC/DC voltage is detected. The ⚡ symbol warns the operator that a dangerous voltage is connected to the unit.



The tester and all associated cables and leads must be checked for signs of damage before the equipment is operated.



Attention! During insulation resistance measurements and Class I and Class II tests, high voltage levels occur within the PrimeTest 200.



Do not exceed the maximum permitted voltage of 30 V AC/DC with respect to earth potential when performing point to point test i.e. Low resistance measuring function Ω and insulation resistance measurement function M Ω ! Electric shock danger!

Where safe operation of the tester is no longer possible, it should be immediately shutdown and secured to prevent accidental operation.

It must be assumed that safe operation is no longer possible:

- if the instrument or the measuring leads show visible signs of damage, or
- the tester does not function, or
- after long periods of storage under adverse environmental conditions.

Important

- **Do not touch the bare probe tips of the measuring leads.**
- **Ensure the measuring leads are plugged into the corresponding sockets on the PrimeTest 200**



**i.e. red lead - red socket - positive
black lead - black socket - negative.**

- **Do not operate the PrimeTest 200 in an explosive gas or dust environment.**

3.0 Accessories

3.1 Standard Accessories

The PrimeTest 200 is supplied with the following items:

- 3.1.1 1 off PrimeTest 200
- 3.1.2 1 off 1.2 M test lead red
- 3.1.3 1 off 1.2 M test lead black
- 3.1.4 1 off alligator clip, red
- 3.1.5 1 off alligator clip, black
- 3.1.6 1 off IEC mains cord
- 3.1.7 1 off professional carry case
- 3.1.8 6 off alkaline batteries 1.5 AA size LR6
- 3.1.9 1 off operating instruction manual

3.2 Optional Accessories

- 3.2.1 Temperature Module (K-Type) 304A952

It should be noted that the following parts of the PrimeTest 200 are user serviceable and must be replaced with appropriate parts as detailed below:

- 1 off fuse, nominal current rating 0.5 A, 600 V AC/DC, Quick Blow, Type F (27B098)
- 2 off fuse, nominal current rating 10 A, 250 V AC/DC, Anti Surge, Type T (27B106)
- 6 off Alkaline batteries, 1.5 V AA size.



Do not open unit, no other serviceable parts.

4.0 Description

The display and selectable functions of the PrimeTest 200 are specified below in conjunction with Figure 1 and Figure 2.











4.1 Rotary Switch

- 1) Test function **0** is the PrimeTest 200 power off position.
- 2) Test function \oplus selects the Class I safety test (earth continuity, insulation resistance) test.
- 3) Test function I_{Δ} selects the differential leakage current test for Class I equipment. Requires mains from power cord.
- 4) Test function RCD selects the RCD test, and also indicates loop resistance. Requires mains from power cord.
- 5) Test function IEC selects the IEC lead (earth continuity, insulation resistance, wire check) test.
- 6) Test function \square selects the Class II safety test (insulation resistance).
- 7) Test function I_t selects the touch current test for Class II equipment. Requires mains from power cord.
- 8) Measuring function Ω selects the Lo ohms (up to 20 K Ω) resistance measurement.
- 9) Measuring function M Ω selects the insulation (up to 200 M Ω) resistance measurement.
- 10) Measuring function \bar{V} selects the voltage (up to 250 V AC/DC) measurement.
- 11) Measuring function $^{\circ}\text{C}$ selects the temperature (up to 400 $^{\circ}\text{C}$) measurement.

4.2 LCD and Keymat

- 1) Digital display for all measurement readings and polarity indication.
- 2) Analogue bargraph display.
- 3) Small digital display used to indicate Pass/Fail criteria or secondary test requirements for selectable test functions e.g. Polarity.
- 4) Battery indicator - \blacksquare symbol is illuminated depending on battery health status (see section 5.6).
- 5) |||| button, enables or disables the audio buzzer. When selected the |||| symbol is illuminated on the LCD display. The audible alarm is activated under the following conditions:-
 - <10 Ω on Ω test function.
 - Zeroing of the test leads.
 - When more than 30 V AC/DC is detected at test lead inputs (see section 8 for affected test functions).
- 6) 🔒 button, enables or disables the lock function and allows test parameters for M Ω and Ω to be continuously applied (see section 5.4). When selected the 🔒 symbol is illuminated on the LCD display.
- 7) ZERO button compensates for the test lead resistance in Ω test function. When selected the $\overset{\sim}{\underset{\text{ZERO}}{\Omega}}$ symbol is illuminated on the LCD display.
- 8) ☀ button, switches the display illumination on or off.
- 9) TEST button is used to start tests and activate the M Ω and Ω measuring functions.
- 10) Rotary switch selects the required test function (see section 4.1).
- 11) Equipment under test (EUT) socket.
- 12) Negative (black) socket.
- 13) Positive (red) socket.
- 14) IEC mains input socket.

5.0 General Information

- 5.1 The polarity indicator ① is automatic. Only one polarity is indicated with respect to the negative black socket ⑫
- 5.2 The bargraph display indicates resistance measurement on a logarithmic scale and voltage measurements on a linear scale.
- 5.3 Range overflow of the digital display ① is automatic and is indicated by the greater than symbol >.
- 5.4 The  button ⑥ allows continuous measurements of $M\Omega$ and Ω without the need to repeatedly press the **TEST** button. To activate the continuous test mode the operator must press and hold the **TEST** button down then simultaneously press the lock  button down. Both buttons can then be released in any order. The  symbol will be illuminated on the LCD display. The  mode when $M\Omega$ measuring function is selected outputs a continuous test voltage between the red and black test leads. The  mode when Ω measuring function is selected outputs a continuous test current between the red and black probes. The operator can deactivate the  mode by pressing either the  or **TEST** buttons.
- 5.5 The PrimeTest 200 will automatically switch off after a period of 5 minutes with no push button or switch action. Where the  mode is enabled the automatic shutdown period is 3 minutes. When a subsequent push button or switch action takes place the instrument automatically switches itself on again.
- 5.6 When the PrimeTest 200 is switched on from power off position 0 to another switch position, an on load battery test occurs. The result of this test determines the available battery capacity. A healthy battery results in no battery symbol being illuminated on the LCD display. A deteriorating battery results in the  symbol being illuminated in the steady state. An unhealthy battery results in a flashing  symbol.

When the flashing  symbol is displayed all test and measurement functions are inhibited to avoid endangering persons by recording false measurements.

- 5.7 During the differential leakage I_{Δ} and touch leakage I_t test functions it is possible that a RCD could be tripped due to the inadvertent testing of a defective EUT.
 - 5.8 Dimensions of the PrimeTest 200 are 265 x 108 x 55mm (L x W x H)
- ## 6.0 Environmental Conditions
- 6.1 The PrimeTest 200 has been designed to perform tests and measurements in a dry environment.
 - 6.2 Maximum barometric elevation for making measurements is 2000M.
 - 6.3 Overvoltage category IEC 60664/IEC 61010, 300V Category II.
 - 6.4 Contamination degree 2 according to IEC 61010-1.
 - 6.5 Protective system IP40 according to IEC 60529.
 - 6.6 Electromagnetic compatibility (EMC). Interference immunity and emitted interference conforming to IEC 61326-1.
 - 6.7 Operating temperature range of 0°C to 40°C, without moisture condensation.
 - 6.8 The PrimeTest 200 can be stored at any temperature in the range -25°C to +65°C (relative humidity up to 90%). The batteries should be taken out of the instrument for storage.

7.0 Electrical Specification

Appendix 1 specifies the operating error for all tests and functions of the PrimeTest 200.

7.1 Earth continuity measuring range (rotary switch position \oplus , and IEC)

Measuring Range	Resolution	Accuracy	Overload Protection
19.99 Ω	0.01 Ω	$\pm 5\%$ +2 digits	300 V AC/DC

Analogue bargraph display	0 to 20 Ω
Bargraph accuracy	10%
Open circuit voltage	>4VDC
Test current	>200mA (0-2 Ω)
Input protection	0.5A (600V) quick blow fuse

An input voltage of ≥ 30 V AC/DC, detected between the + and - input measuring terminals, disables the earth continuity measuring circuit. A repetitive audible alarm is activated and a flashing high voltage ⚡ symbol is displayed on the LCD.

The maximum number of continuity tests, with a duty cycle specified by BS EN 61557-4 Section 6.6, is 1900 repetitions.

7.2 Insulation resistance measuring range (rotary switch position \oplus , \square , IEC and M Ω).

Measuring Range	Resolution	Accuracy	Overload Protection
2M Ω	0.01M Ω	$\pm 2\%$ +2 digits	300 V AC/DC
20M Ω	0.1M Ω	$\pm 2\%$ +2 digits	300 V AC/DC
200M Ω	1M Ω	$\pm 5\%$ +2 digits	300 V AC/DC

Analogue bargraph display	0 to 200M Ω and infinity
Bargraph accuracy	10%
Test voltage	>500VDC at 1mA, <750VDC for o/c
Test voltage accuracy	+20%, -0%
Test current	<2mA for s/c
Input protection	0.5A (600 V) quick blow fuse.

An input voltage of ≥ 30 V AC/DC, detected between the + and - input measuring terminals, disables the insulation resistance measuring circuit. A repetitive audible alarm is activated and a flashing high voltage ⚡ symbol is displayed on the LCD.

The maximum number of insulation tests, with a duty cycle specified by BS EN 61557-2 Section 6.7, is 2000 repetitions.

7.3 Resistance measuring range Ω \lll

Measuring Range	Resolution	Accuracy	Overload Protection
19.99 Ω	0.01 Ω	$\pm 5\%$ +2 digits	300 V AC/DC
1999 Ω	1 Ω	$\pm 5\%$ +2 digits	300 V AC/DC
20.00K Ω	10 Ω	$\pm 5\%$ +2 digits	300 V AC/DC

Analogue bargraph display	0 to 20K Ω and infinity
Bargraph accuracy	10%
Test current	>200mA (0-2R)
Open circuit voltage	> 4 V DC
Input protection	0.5A (600 V) quick blow fuse.

Zero compensation of the test leads up to 10 Ω . The internal buzzer sounds when the measured resistance <10 Ω .

An input voltage of ≥ 30 V AC/DC, detected between the + and - input measuring terminals, disables the resistance measuring circuit. A repetitive audible alarm is activated and a flashing high voltage ⚡ symbol is displayed on the LCD.

7.4 Voltage measuring range

Measuring Range	Resolution	Accuracy	Overload Protection
250 V AC/DC	1V	±2% +2 digits	300 V AC/DC

Frequency Range	up to 400Hz
Analogue bargraph display	0 to 250 V
Bargraph accuracy	10%
Input protection	>20MΩ

An input voltage of ≥ 30 V AC/DC, detected between the + and - input measuring terminals, disables the voltage measurement function. A repetitive audible alarm is activated and a flashing high voltage ⚡ symbol is displayed on the LCD.

7.5 IEC lead test

The IEC lead test is a sequence of earth continuity measurement (section 7.1) - insulation resistance measurement (section 7.2) - Live/Neutral checks for o/c, s/c and crossed conductors in the IEC lead.

Test voltage	9 VDC
Test duration	10 seconds

7.6 Temperature measuring range °C

Measuring Range	Resolution	Accuracy	Overload Protection
-50°C to +400°C	0.1°C	±5% +2digits	300 V AC/DC

An input voltage of ≥ 30 V AC/DC, detected between the + and - input measuring terminals, disables the temperature measurement function. A repetitive audible alarm is activated and a flashing high voltage ⚡ symbol is displayed on the LCD.

7.7 Touch current measurement

Measuring Range	Resolution	Accuracy	Overload Protection
3.5mA	0.01mA	±10% + 2 digits (5° - 40°) ±15% + 2 digits (0° - 5°)	N/A

Test voltage	mains supply @ 230V - 15%/+10% @ 10A max
Frequency	50Hz ±1%
Test duration	2 seconds minimum
Frequency response	IEC 61010-1 Annex A.1

An input voltage of ≥ 30 V AC/DC, detected between the + and - input measuring terminals, disables the touch current test function. A repetitive audible alarm is activated and a flashing high voltage ⚡ symbol is displayed on the LCD.

The test is also disabled when phase-neutral (PN) or phase-earth (PE) voltage is not at mains potential or a voltage of 40 V AC or greater exists between neutral-earth (NE).

7.8 Differential current measurement

Measuring Range	Resolution	Accuracy	Overload Protection
19.99m A	0.01mA	±5% + 2 digits	N/A

Test voltage	mains supply @ 230V - 15%/+10% @ 10A max
Frequency	50Hz ±1%
Test duration	2 seconds minimum
Frequency response	IEC 61010-1 Annex A.1 (from 40Hz)

An input voltage of ≥ 30 V AC/DC, detected between the + and - input measuring terminals, disables the differential current test function. A repetitive audible alarm is activated and a flashing high voltage ⚡ symbol is displayed on the LCD.

The test is also disabled when phase-neutral (PN) or phase-earth (PE) voltage is not at mains potential or a voltage of 40 V AC or greater exists between neutral-earth (NE).

7.9 RCD test

Test current	30mA r.m.s
Test current accuracy	+5%, - 0%
Test duration	500ms maximum if RCD does not trip
Trip time accuracy	±10%

An input voltage of ≥ 30 V AC/DC, detected between the + and - input measuring terminals, disables the RCD test function. A repetitive audible alarm is activated and a flashing high voltage ⚡ symbol is displayed on the LCD.

The test is disabled when phase - neutral (PN) or phase -earth (PE) voltage is not at mains potential or a voltage of 40 VAC or greater exists between neutral - earth (NE).

8.0 Operation of test functions

8.1 Safety test, Class I Ⓢ

See figure 3

- 8.1.1 Select the Class I Ⓢ test function on the rotary switch (10). Ensure the IEC mains lead is disconnected from the PrimeTest 200.
- 8.1.2 The LCD will display a probe signal to indicate that an earth bond test lead is required. This test function is selected when the equipment to be tested is fitted with a protective earth conductor.
- 8.1.3 Plug the equipment under test (EUT) into the EUT socket (11) on the front of the PrimeTest 200.
- 8.1.4 Plug the black test lead into the negative, black socket (12) on the PrimeTest 200.
- 8.1.5 Connect the other end of the black test lead to exposed metalwork on the EUT.
- 8.1.6 To start a Class I safety test sequence, press the **TEST** button (9).
- 8.1.7 The earth continuity resistance for the EUT is measured at ± 200 mA. The large display (2) indicates the highest digital and analogue earth resistance, Ω , the small display (3) indicates a PASS/FAIL status. An additional visual display of a ✓ or ✗ also indicates the PASS/FAIL status.
- 8.1.8 Earth continuity resistance value is held on the LCD display for a period of 1 second. A PASS or FAIL indication will be shown, depending on value of the displayed reading.
- 8.1.9 An earth continuity resistance that fails will terminate the Class I PAT test, a PASS will automatically sequence to the insulation resistance test.



During an insulation resistance measurement a high voltage is applied between the Live/Neutral and Earth of the EUT. It should be noted that this voltage can also be present on the bare metalwork of the EUT.

- 8.1.10 The insulation resistance of the EUT is measured over a period of 2 seconds. The large display (2) indicates digital analogue insulation resistance, M Ω , the small display (3) indicates a PASS/FAIL status. An additional visual display of a ✓ or ✗ also indicates PASS/FAIL status.
- 8.1.11 The insulation resistance value will remain displayed until another rotary switch action.

8.2 Differential Leakage Current, I_{Δ}

See figure 4.



Attention - The Red or Black 4mm test sockets must not be used whilst the PrimeTest 200 is performing a leakage test. Electric Shock Danger.



Attention - before a differential leakage current test is performed on a Class I EUT the operator must ensure that the EUT has already passed a Class I safety test.



Attention - An RCD may be triggered if the EUT is defective.



Warning - it is important that the user verifies that an appliance with moving parts (e.g. an electric drill) is safely mounted to allow movement without causing damage to equipment or personnel.

- 8.2.1 Plug the PrimeTest 200 into a mains power socket using the supplied IEC lead.
- 8.2.2 Plug the equipment under test (EUT) into the EUT socket (11) on the front of the PrimeTest 200
- 8.2.3 Select the differential leakage current test function, I_{Δ} on the rotary switch (10).
- 8.2.4 When the **TEST** button (9) is pressed the PrimeTest 200 checks the wiring of the power socket being used. If the line potentials are correct then the LCD will display the symbols PE and PN in the steady state. Where a fault exists, then the appropriate symbol will flash (see Appendix 2) along with the lightning bolt symbol being displayed in the steady state. A fault condition will inhibit the differential leakage current test.



If a power test is selected but the mains supply has not been connected to the PrimeTest 200 then PE and PN symbols will flash and the test is inhibited.

- 8.2.5 To start the differential leakage test, press the **TEST** button (9). Mains power is applied to the EUT for a period of 2 seconds.
- 8.2.6 Where a longer differential leakage test is required the operator must press and hold the **TEST** button down, then simultaneously press the lock (1) button down. Mains power is applied to the EUT for a period of up to 30 seconds. The operator can deactivate the (1) mode and end the test by pressing the (1) button.
- 8.2.7 The large digital display (2) indicates the differential leakage current, in mA, the small digital display (3) indicates a PASS/FAIL status. An additional visual display of a ✓ or X also indicate the PASS/FAIL status.
- 8.2.7A **Schuko Version.** The small display (3) will show 1-2 to indicate that the first in a sequence of two differential leakage measurements is being recorded. The large display (2) indicates the differential leakage current, in mA, the small display (3) will revert to indicating a PASS/FAIL status. An additional visual display of a ✓ or X also indicate the PASS/FAIL status.
- 8.2.7B **Schuko Version.** If the result is a FAIL then the test is terminated else a PASS condition allows the test to continue. The operator again presses the **TEST** button. The small display (3) will show 2-2 to indicate that the second in a sequence of two differential leakage measurements is being recorded. The large display (2) indicates the differential leakage current, in mA, the small display (3) will revert to indicating a PASS/FAIL status. An additional visual display of a ✓ or X also indicate the PASS/FAIL status.
- 8.2.8 The differential leakage current will remain displayed until another rotary switch or push button action.



Attention - the differential leakage current measurement can be affected by exposure of the PrimeTest 200 to magnetic fields or current being absorbed by the EUT during differential leakage measurements.



Attention - where the input current waveform displays a crest factor of 2 then a percentage error of 2.2% is recorded on the PrimeTest 200 measured value.

8.3 Residual Current Device, RCD, Test

See figure 5



Attention - The Red or Black 4mm test sockets must not be used whilst the PrimeTest 200 is performing an RCD / Earth Loop test. Electric Shock Danger!

- 8.3.1 Plug the PrimeTest 200 into the RCD using the supplied IEC lead. The adaptor is then plugged into a mains power socket.
- 8.3.2 Select the RCD test function on the rotary switch (10).
- 8.3.3 Switch on the mains power.
- 8.3.4 The PrimeTest 200 automatically checks the wiring of the power socket being used. If the line potentials are correct then the LCD will display the symbols PE and PN in the steady state. Where a fault exists then the appropriate symbol will flash (see Appendix 2) along with the ⚡ symbol being displayed in the steady state. A fault condition will inhibit the RCD test.



If a power test is selected but the mains supply has not been connected to the PrimeTest 200 then PE and PN symbols will flash and the test is inhibited.

- 8.3.5 The earth loop resistance is checked and an ohmic range selected on the large digital display. This resistance value is displayed until the **TEST** button (9) is pressed.
- 8.3.5A **Schuko Version.** The earth loop resistance range is inhibited.
- 8.3.6 To start the RCD test, press the **TEST** button (9).
- 8.3.7 The PrimeTest 200 will produce a test current of 30mA r.m.s. in the protective earth of the supply. The test will commence at the start of a positive half cycle.
- 8.3.8 The RCD will trip. The time taken to trip for the positive half cycle, or the default time if no trip occurred is displayed on the PrimeTest 200.
- 8.3.9 A flashing RCD time and displayed **X** indicates that the RCD has failed to trip within 500ms.
- 8.3.10 Re-apply power to the PrimeTest 200 by resetting the RCD and press the **TEST** button (9).
- 8.3.11 The PrimeTest 200 will produce a test current of 30mA r.m.s. in the protective earth of the supply. The test will commence at the start of a negative half cycle.
- 8.3.12 The RCD will trip. The time taken to trip for the negative half cycle, or the default time if no trip occurred is displayed on the PrimeTest 200.
- 8.3.13 A flashing RCD time and displayed **X** indicates that the RCD has failed to trip within 500ms.
- 8.3.14 The RCD trip time will remain displayed until another rotary switch or push button action.

8.4 IEC Lead TEST, IEC

See Figure 6.

- 8.4.1 Select the IEC test function on the rotary switch (10).



Do not connect the IEC lead to the PrimeTest 200, in preparation for an IEC lead test, before the unit is switched on. Failure to comply will result in an error message displayed on the LCD.

- 8.4.2 To test IEC leads connect the IEC socket side of the lead into the IEC plug (14). Connect the mains plug side of the lead into the EUT socket (11).

- 8.4.3 To start an IEC lead test press the **TEST** button (9).

- 8.4.4 The earth continuity resistance for the lead is measured at $\pm 200\text{mA}$. The large display (2) indicates the highest digital and analogue earth resistance, Ω . An earth continuity resistance $>20\ \Omega$ will result in a FAIL. An additional visual display of a \checkmark or \times also indicates the PASS/FAIL status.



Attention - 13A IEC or extension leads of different cable lengths will have different resistances. As a rule of thumb:-

12 metres of 13A cable	0.2 Ω
6 metres of 13A cable	0.1 Ω
3 metres of 13A cable	0.05 Ω

- 8.4.5 The earth continuity resistance value is held on the LCD display for a period of 1 second.

- 8.4.6 An earth continuity resistance that FAILS will terminate the IEC lead test, otherwise it will automatically sequence to the insulation resistance test.



During an insulation resistance measurement a high voltage is applied between the LIVE/Neutral and common of the IEC lead.

- 8.4.7 The insulation resistance of the lead is measured over a period of 2 seconds. The large display (2) indicates digital and analogue insulation resistance, $\text{M}\Omega$, the small display (3) indicates a PASS/FAIL status. An additional visual display of a \checkmark or \times also indicates PASS/FAIL status.

- 8.4.8 Insulation resistance value is held on the LCD display for a period of 1 second. The displayed resistance value will flash if a FAIL and remain steady if a PASS.

- 8.4.9 An insulation resistance that fails will terminate the lead test, a pass will automatically sequence to the lead wiring test and the small digital display (3) will indicate "LEAD".

- 8.4.10 The wiring of the IEC lead is tested over a period of 2 seconds. The large digital display (2) indicates a PASS/FAIL status for the lead. An additional visual indication of a \checkmark or \times also indicates PASS/FAIL status.



The IEC lead wiring test checks for open circuit, short circuit or crossed wires within the IEC lead.

- 8.4.11 If this is the last IEC lead test or the only test then the results will remain displayed until another rotary switch or push button action.

8.5 Safety Test, Class II

See Figure 7

- 8.5.1 Select the Class II test function on the rotary switch (10). The LCD will display a probe symbol to indicate that a safety test lead is required. Ensure the IEC mains lead is disconnected from the PrimeTest 200.

- 8.5.2 Plug the equipment under test (EUT) into the EUT socket (11) on the front of the PrimeTest 200.
- 8.5.3 Plug the black insulation test lead into the negative, black, socket (12) on the PrimeTest 200.
- 8.5.4 Connect the other end of the black insulation test lead to any exposed metal parts on the outer cover of the EUT or near the mains input or mains switch if there are no exposed metal parts.
- 8.5.5 To start a Class II safety test, press the **TEST** button (9)



During an insulation resistance measurement a high voltage is applied between the Live/Neutral of the EUT and the black test probe. It should be noted that this voltage can also be present on bare metalwork of the EUT.

- 8.5.6 The insulation resistance of the EUT is measured over a period of 2 seconds. The large display (2) indicates a digital and analogue insulation MΩ, the small display (3) indicates a PASS/FAIL status. An additional visual display of a ✓ or ✗ also indicates PASS/FAIL status.
- 8.5.7 Insulation resistance value is held on the LCD display for a period of 1 second. The displayed insulation resistance will flash if a FAIL and remain steady if a PASS.
- 8.5.8 The result will remain displayed until another rotary switch or pushbutton action.

8.6 Touch Leakage Current, I_t

See figure 8



Attention - before a touch leakage current test is performed on a Class II EUT the operator must ensure that the EUT has already passed a Class II safety test.



Attention - An RCD may be triggered if the EUT is defective.



Warning - It is important that the user verifies that an appliance with moving parts (e.g. an electric drill) is safely mounted to allow movement without causing damage to equipment or personnel.

- 8.6.1 Plug the PrimeTest 200 into a mains power socket using the supplied IEC lead.
- 8.6.2 Select the touch leakage current test function on the rotary switch (10). The LCD will display a probe signal to indicate that a safety test lead is required.
- 8.6.3 Plug the equipment under test into the EUT socket (11) on the front of the PrimeTest 200.
- 8.6.4 Plug the black test lead into the negative, black socket (12) on the PrimeTest 200.
- 8.6.5 Connect the other end of the black test lead to exposed metalwork on the EUT.
- 8.6.6 When the **TEST** button (9) is pressed the PrimeTest 200 checks the wiring of the power socket being used. If the line potentials are correct then the LCD will display the symbols PE and PN in the steady state. Where a fault exists then the appropriate symbol will flash (see Appendix 2) along with ⚡ symbol being displayed in the steady state. A fault condition will inhibit the touch leakage test.



If the power test is selected but the mains supply has not been connected to the PrimeTest 200 then PE and PN symbols will flash and the test is inhibited.

- 8.6.7 To start the touch leakage test, press the **TEST** button (9). Mains power is applied to the EUT for a period of 2 seconds.
- 8.6.8 When a longer touch leakage test is required the operator must press and hold the **TEST** button down, then simultaneously press the lock (i) button down. Mains power is applied to the EUT for a period of up to 30 seconds, The operator can deactivate the (i) mode and end the test by pressing the (i) button.
- 8.6.9 The large digital display (2) indicates the touch leakage current, in mA, the small digital display (3) indicates a PASS/FAIL status. An additional visual display of a ✓ or ✗ also indicates the PASS/FAIL status.
- 8.6.9A **Schuko Version.** The small display (3) will show 1-2 to indicate that the first in a sequence of two touch leakage measurements is being recorded. The large display (2) indicates the touch leakage current, in mA, the small display (3) will revert to indicating a PASS/FAIL status. An additional visual display of a ✓ or ✗ also indicates the PASS/FAIL status.
- 8.6.9B **Schuko Version.** If the result is a FAIL then the test is terminated else a PASS condition allows the test to continue. The operator again presses the **TEST** button. The small display (3) will show 2-2 to indicate that the second in a sequence of two touch leakage measurements is being recorded. The large display (2) indicates the touch leakage current, in mA, the small display (3) will revert to indicating a PASS/FAIL status. An additional visual display of a ✓ or ✗ also indicates the PASS/FAIL status.
- 8.6.10 The touch leakage current will remain displayed until another rotary switch or pushbutton action.

8.7 Low resistance measuring function, (Ω)

See figure 9



Attention - Disconnect the IEC mains cable from the IEC socket before commencing this test. Electric Shock Danger!



Attention - an error can occur in the resistance measurement when parallel impedance is connected from additional working circuits and by circulating current.



Do not exceed the maximum permitted voltage of 30 V AC/DC with respect to earth potential! Electric shock danger!

- 8.7.1 Ensure the circuit or test object to be measured is voltage free. Ensure the IEC mains lead is disconnected from the PrimeTest 200.
- 8.7.2 Select the resistance measurement function on the rotary switch (10). The LCD will display two probe symbols to indicate that both test leads are required.
- 8.7.3 Plug the black test lead into the negative, black socket (12) on the PrimeTest 200.
- 8.7.4 Plug the red test lead into the positive, red socket (13) on the PrimeTest 200.
- 8.7.5 Compensate for the resistance of the test leads (zero adjustment) by connecting the two probe tips together. Press and hold the **Zero** button (7) until the audible alarm sounds, the large digital display (2) indicates 0.00 in Ω and the Ω_{Zero} symbol is displayed in the steady state.



The low resistance measuring function measures resistance values in the range 0-20K Ω . Any zeroing of the safety test leads will only affect resistance measurements 0 -20 Ω

- 8.7.6 Connect the red and black test leads to the circuit or object to be measured.

- 8.7.7 If an external voltage of 30 V AC/DC or greater is present at the tips of the test probes a repetitive audible alarm sounds along with the flashing high voltage ⚡ symbol being displayed and the **TEST** button (9) is inhibited.
- 8.7.8 In order to proceed, remove the external voltage from the circuit or test object to be measured.
- 8.7.9 To perform a resistance measurement, press the **TEST** test button (9)
- 8.7.10 The large display (2) indicates the digital and analogue resistance measurement in Ω to 19.99 then $K\Omega$ to 20K.



Where the measured resistance value is greater than 20K Ω the large display indicates > 20.0 K Ω . If the display show F3 refer to section 9.5

8.8 Insulation Resistance Measurement Function, M Ω .

See Figure 10



Attention - Disconnect the IEC mains cable from the IEC socket before commencing this test. Electric Shock Danger!



During an insulation resistance measurement a high voltage is present at the tips of the test probes. It should be noted that this voltage can be present on bare metal parts of the appliance being tested.



Do not exceed the maximum permitted voltage of 30 V AC/DC with respect to earth potential! Electric shock danger!

- 8.8.1 Ensure the circuit or test object to be measured is voltage free. Ensure the IEC mains lead is disconnected from the PrimeTest 200.
- 8.8.2 Select the insulation resistance measurement function on the rotary switch (10). The LCD will display two probe symbols to indicate that both safety test leads are required.
- 8.8.3 Plug the black test lead into the negative, black socket (12) on the PrimeTest 200.
- 8.8.4 Plug the red test lead into the positive, red, socket (13) on the PrimeTest 200.
- 8.8.5 Connect the red and black test leads to the circuit or object to be measured.
- 8.8.6 If an external voltage of 30 V AC/DC or greater is present at the tips of the test probes a repetitive audible alarm sounds along with the flashing high voltage ⚡ symbol being displayed and the **TEST** button (9) is inhibited.
- 8.8.7 In order to proceed, remove the external voltage from the circuit or test object to be measured.
- 8.8.8 To perform an insulation resistance measurement, press the **TEST** button (9).
- 8.8.9 The large display (2) indicates the digital and analogue insulation resistance measurement in M Ω up to 200 M Ω .



Where the measured insulation resistance value is greater than 200M Ω , the large display indicates >200M Ω . If the display shows F3 refer to section 9.5

8.9 Temperature Measurement Function, °C.

See Figure 11

**Attention - Disconnect the IEC mains cable from the IEC socket before commencing this test. Electric Shock Danger!****Do not exceed the maximum permitted voltage of 30 V AC/DC with respect to earth potential! Electric shock danger!**

- 8.9.1 Select the temperature measurement function on the rotary switch (10). The LCD will display two probe symbols to indicate that both the red and black sockets require connections. Ensure the IEC mains lead is disconnected from the PrimeTest 200.
- 8.9.2 Plug the PrimeTest 200 temperature module (see 3.2.1) into the red (13) and black (12) sockets on the PrimeTest 200.
- 8.9.3 Plug the type K thermocouple into the PrimeTest 200 temperature module. Select the switch position to °C on the top of the temperature module.
- 8.9.4 The large digital display (2) indicates the temperature measurement in °C from -50 to 400°C.

**Where the measured temperature value is greater than +400°C the large display indicates >400°C. Where the measured temperature value is less than -50°C the large display indicates <-50°C****8.10 Voltage Measuring Function, \bar{V}**

See Figure 12a and 12b

- 8.10.1 Select the voltage measurement function on the rotary switch (10).
- 8.10.2 Plug the voltage measurement adaptor into the IEC mains input plug (14) on the end of the PrimeTest 200.
- 8.10.3 Plug the black test lead into the negative, black socket on the voltage measurement adaptor.
- 8.10.4 Plug the red test lead into the positive, red socket on the voltage measurement adaptor.
- 8.10.5 Connect the red and black test leads to the point to be measured.
- 8.10.6 The large display (2) indicates the digital and analogue voltage measurement in V AC/DC up to 300 V AC/DC.

**Where the measured voltage value, is greater than 250 V AC/DC the large display indicates > 250 V AC/DC for over range.**

- 8.10.7 An input voltage of ≥ 30 V AC/DC, detected between the + and - input measuring terminals, disables the voltage measurement function. A repetitive audible alarm is activated and a flashing high voltage ⚡ symbol is displayed on the LCD.

**The PrimeTest 200 indicates either a DC (direct) voltage or an AC (alternating) voltage. If the measured voltage has a DC component and an AC component, only the component which has the greater magnitude will be measured and displayed.****9.0 Maintenance****Before opening the PrimeTest 200 ensure that it is disconnected from all voltage! Electric shock danger!**

9.1 Preparing to work on the PrimeTest 200.

Make the PrimeTest 200 voltage free as follows, before opening the instrument.

- 9.1.1 Disconnect the two test leads from the measuring point.
- 9.1.2 Disconnect the IEC mains cable, from the IEC socket.
- 9.1.3 Remove the test leads from the PrimeTest 200.
- 9.1.4 Select the test function 0, power off position, on the rotary switch (11).

9.2 Securing the PrimeTest 200

Under certain conditions safe operation of the PrimeTest 200 can no longer be assumed.

- 9.2.1 Visible damage of the instrument case.
- 9.2.2 Incorrect measurement results.
- 9.2.3 Recognisable abuse to the instrument due to prolonged storage under improper conditions.
- 9.2.4 Recognisable abuse to the instrument due to extraordinary transportation stress.
- 9.2.5 In these cases, the PrimeTest 200 should be immediately switched off, disconnected from any test or measurement function and secured to prevent any further use.

9.3 Cleaning

- 9.3.1 Clean the external case of the PrimeTest 200 with a clean dry cloth.
- 9.3.2 Avoid using solvents and abrasive scouring agents to clean the external case of the PrimeTest 200.
- 9.3.3 Check the battery contacts and compartment are free of electrolytic contamination.
- 9.3.4 Any contamination of the battery contacts or compartment should be cleaned with a dry cloth.

9.4 Battery Replacement

Before opening the PrimeTest 200 ensure that it is disconnected from all voltage! Electric shock danger!

When the  symbol is displayed the batteries of the PrimeTest 200 must be replaced (See section 5.6). Replace the batteries as follows:

- 9.4.1 Disconnect the two test leads from the measuring point.
- 9.4.2 Disconnect the IEC socket from the IEC plug.
- 9.4.3 Remove the test leads from the PrimeTest 200.
- 9.4.4 Select the test function 0, power off position on the rotary switch (11).
- 9.4.5 Position the PrimeTest 200 face down and release the captive screw in the battery compartment cover.
- 9.4.6 Remove the battery compartment cover.
- 9.4.7 Remove the discharged batteries from the compartment.

- 9.4.8 Insert a new set of batteries into the battery compartment ensuring that the battery polarity matches the marking on the inside of the battery compartment.
- 9.4.9 Relocate the battery cover over the battery compartment and fasten in position with the battery cover captive screw.



This meter contains alkaline batteries. Do not dispose of these batteries with other solid waste. Used batteries should be disposed of by a qualified recycler or hazardous materials handler.

9.5 Checking the point-to-point output fuse.

- 9.5.1 Select the measuring function Ω on the rotary switch (11).
- 9.5.2 Plug the black test lead into the negative, black socket (12) on the PrimeTest 200.
- 9.5.3 Plug the red test lead into the positive, red socket (13) on the PrimeTest 200.
- 9.5.4 Connect the tips of the red and black test probes together.
- 9.5.5 Press the **TEST** button (9).
- 9.5.6 The large display (2) indicates the digital and analogue internal safety lead resistance.
- 9.5.7 If the fuse is intact a reading of $<0.1\Omega$ will be displayed.
- 9.5.8 If the fuse is defective, F3 will be displayed.

9.6 Checking the EUT Socket Fuses.

- 9.6.1 Plug the PrimeTest 200 into the mains power socket, using the IEC lead provided.
- 9.6.2 Select one of the three power tests, differential leakage current I_{Δ} , touch leakage current I_{Δ} or RCD trip on the rotary switch (11).
- 9.6.3 If the fuses are intact then the symbols PE, PN or NE will be displayed in the appropriate manner (see section 8.2.4) depending on the configuration of the power socket being used.
- 9.6.4 If either one or both fuses are defective then the symbols PE, PN and NE will all flash on the display.

9.7 Replacing All Fuses.



Before opening the PrimeTest 200 ensure that it is disconnected from all voltages! Electric shock danger!



All replacement fuse types are specified for ratings and size on the battery compartment cover on the rear of the PrimeTest 200.

- 9.7.1 Disconnect the two test leads from the measuring point.
- 9.7.2 Disconnect the IEC socket from the IEC plug.
- 9.7.3 Remove the test leads from the PrimeTest 200.
- 9.7.4 Select the test function 0, power off position on the rotary switch (11).
- 9.7.5 Position the PrimeTest 200 face down and release the captive screw in the battery compartment.
- 9.7.6 Remove the battery compartment cover.

- 9.7.7 Lift one end of the defective fuse out of the fuse holder with the help of a flat bladed screwdriver.
- 9.7.8 Lift the defective fuse completely out of the fuse holder.
- 9.7.9 Insert a new fuse as described and specified by the text on the battery compartment cover.
- 9.7.10 Ensure that the new fuse is seated and centred in the fuse holder.
- 9.7.11 Relocate the battery cover over the battery compartment and fasten in position with the battery cover captive screw.

9.8 Calibration.

To maintain the specified accuracy of the measurement results, the instrument must be recalibrated at regular intervals by either the manufacturer or an authorised Seaward Service Agent. We recommend a recalibration period of one year.

9.9 Spare Parts.

Fuse 31.75mm x 6.35mm 0.5A 600V Type F
Fuse 20mm x 5mm 10A 250 V Type T
Test Leads (with alligator clips)
Carry Case

Seaward Part No: 27B098
Seaward Part No: 27B106
Seaward Part No: 44B090
Seaward Part No: 71G082

Appendix 1

Class 1 Earth Bond			
Intrinsic Error or Influence Quantity	Reference Conditions or Rated Operating Conditions	Code	Max Error Seen
Intrinsic Error	Reference Conditions	A	5%
Position	Reference Positions $\pm 90^\circ$	E ₁	N/A
Supply Voltage	At the Limits Specified by the Manufacturer	E ₂	0.49%
Temperature	0°C and 35°C	E ₃	0.4%
Absorbed Current of Device on Test	Maximum Absorbed Current of the Device on Test	E ₄	N/A
Low-frequency Magnetic Field	Low-frequency Magnetic field 0.4 kA/m	E ₅	N/A
Not Used	Not Used	E ₆	N/A
Capacitance	C _{max} = 1uF	E ₇	N/A
Waveform	R.M.S. CR ≤ 2	E ₈	N/A
Operating Error	$B=A+1.15\sqrt{E_1^2+E_2^2+E_3^2+E_4^2+E_5^2+E_6^2+E_7^2+E_8^2}$		5.73%

Class 1 Insulation			
Intrinsic Error or Influence Quantity	Reference Conditions or Rated Operating Conditions	Code	Max Error Seen
Intrinsic Error	Reference Conditions	A	5%
Position	Reference Positions $\pm 90^\circ$	E ₁	N/A
Supply Voltage	At the Limits Specified by the Manufacturer	E ₂	0.52%
Temperature	0°C and 35°C	E ₃	1%
Absorbed Current of Device on Test	Maximum Absorbed Current of the Device on Test	E ₄	N/A
Low-frequency Magnetic Field	Low-frequency Magnetic field 0.4 kA/m	E ₅	N/A
Not Used	Not Used	E ₆	N/A
Capacitance	C _{max} = 1uF	E ₇	N/A
Waveform	R.M.S. CR ≤ 2	E ₈	N/A
Operating Error	$B=A+1.15\sqrt{E_1^2+E_2^2+E_3^2+E_4^2+E_5^2+E_6^2+E_7^2+E_8^2}$		6.30%

IEC Earth Bond			
Intrinsic Error or Influence Quantity	Reference Conditions or Rated Operating Conditions	Code	Max Error Seen
Intrinsic Error	Reference Conditions	A	5%
Position	Reference Positions $\pm 90^\circ$	E ₁	N/A
Supply Voltage	At the Limits Specified by the Manufacturer	E ₂	0.77%
Temperature	0°C and 35°C	E ₃	0.4%
Absorbed Current of Device on Test	Maximum Absorbed Current of the Device on Test	E ₄	N/A
Low-frequency Magnetic Field	Low-frequency Magnetic field 0.4 kA/m	E ₅	N/A
Not Used	Not Used	E ₆	N/A
Capacitance	C _{max} = 1uF	E ₇	N/A
Waveform	R.M.S. CR ≤ 2	E ₈	N/A
Operating Error	$B=A+1.15\sqrt{E_1^2+E_2^2+E_3^2+E_4^2+E_5^2+E_6^2+E_7^2+E_8^2}$		6.00%

IEC Insulation			
Intrinsic Error or Influence Quantity	Reference Conditions or Rated Operating Conditions	Code	Max Error Seen
Intrinsic Error	Reference Conditions	A	5%
Position	Reference Positions $\pm 90^\circ$	E ₁	N/A
Supply Voltage	At the Limits Specified by the Manufacturer	E ₂	1%
Temperature	0°C and 35°C	E ₃	1%
Absorbed Current of Device on Test	Maximum Absorbed Current of the Device on Test	E ₄	N/A
Low-frequency Magnetic Field	Low-frequency Magnetic field 0.4 kA/m	E ₅	N/A
Not Used	Not Used	E ₆	N/A
Capacitance	C _{max} = 1uF	E ₇	N/A
Waveform	R.M.S. CR ≤ 2	E ₈	N/A
Operating Error	$B=A+1.15\sqrt{E_1^2+E_2^2+E_3^2+E_4^2+E_5^2+E_6^2+E_7^2+E_8^2}$		6.63%

Class 2 Insulation			
Intrinsic Error or Influence Quantity	Reference Conditions or Rated Operating Conditions	Code	Max Error Seen
Intrinsic Error	Reference Conditions	A	5%
Position	Reference Positions $\pm 90^\circ$	E ₁	N/A
Supply Voltage	At the Limits Specified by the Manufacturer	E ₂	0.53%
Temperature	0°C and 35°C	E ₃	1%
Absorbed Current of Device on Test	Maximum Absorbed Current of the Device on Test	E ₄	N/A
Low-frequency Magnetic Field	Low-frequency Magnetic field 0.4 kA/m	E ₅	N/A
Not Used	Not Used	E ₆	N/A
Capacitance	C _{max} = 1uF	E ₇	N/A
Waveform	R.M.S. CR ≤ 2	E ₈	N/A
Operating Error	$B=A+1.15\sqrt{E_1^2+E_2^2+E_3^2+E_4^2+E_5^2+E_6^2+E_7^2+E_8^2}$		6.30%

Point to Point Resistance			
Intrinsic Error or Influence Quantity	Reference Conditions or Rated Operating Conditions	Code	Max Error Seen
Intrinsic Error	Reference Conditions	A	5%
Position	Reference Positions $\pm 90^\circ$	E ₁	N/A
Supply Voltage	At the Limits Specified by the Manufacturer	E ₂	0.6%
Temperature	0°C and 35°C	E ₃	1.4%
Absorbed Current of Device on Test	Maximum Absorbed Current of the Device on Test	E ₄	N/A
Low-frequency Magnetic Field	Low-frequency Magnetic field 0.4 kA/m	E ₅	N/A
Not Used	Not Used	E ₆	N/A
Capacitance	C _{max} = 1uF	E ₇	N/A
Waveform	R.M.S. CR ≤ 2	E ₈	N/A
Operating Error	$B=A+1.15\sqrt{E_1^2+E_2^2+E_3^2+E_4^2+E_5^2+E_6^2+E_7^2+E_8^2}$		6.75%

Point to Point Insulation			
Intrinsic Error or Influence Quantity	Reference Conditions or Rated Operating Conditions	Code	Max Error Seen
Intrinsic Error	Reference Conditions	A	5%
Position	Reference Positions $\pm 90^\circ$	E ₁	N/A
Supply Voltage	At the Limits Specified by the Manufacturer	E ₂	1.6%
Temperature	0°C and 35°C	E ₃	1%
Absorbed Current of Device on Test	Maximum Absorbed Current of the Device on Test	E ₄	N/A
Low-frequency Magnetic Field	Low-frequency Magnetic field 0.4 kA/m	E ₅	N/A
Not Used	Not Used	E ₆	N/A
Capacitance	C _{max} = 1uF	E ₇	2%
Waveform	R.M.S. CR ≤ 2	E ₈	N/A
Operating Error	$B=A+1.15\sqrt{E_1^2+E_2^2+E_3^2+E_4^2+E_5^2+E_6^2+E_7^2+E_8^2}$		7.17%

Differential Leakage			
Intrinsic Error or Influence Quantity	Reference Conditions or Rated Operating Conditions	Code	Max Error Seen
Intrinsic Error	Reference Conditions	A	5%
Position	Reference Positions $\pm 90^\circ$	E ₁	N/A
Supply Voltage	At the Limits Specified by the Manufacturer	E ₂	0.56%
Temperature	0°C and 35°C	E ₃	0.81%
Absorbed Current of Device on Test	Maximum Absorbed Current of the Device on Test	E ₄	1.5%
Low-frequency Magnetic Field	Low-frequency Magnetic field 0.4 kA/m	E ₅	N/A
Not Used	Not Used	E ₆	N/A
Capacitance	C _{max} = 1uF	E ₇	N/A
Waveform	R.M.S. CR ≤ 2	E ₈	2.5%
Operating Error	$B=A+1.15\sqrt{E_1^2+E_2^2+E_3^2+E_4^2+E_5^2+E_6^2+E_7^2+E_8^2}$		8.54%

Touch Leakage			
Intrinsic Error or Influence Quantity	Reference Conditions or Rated Operating Conditions	Code	Max Error Seen
Intrinsic Error	Reference Conditions	A	10%
Position	Reference Positions $\pm 90^\circ$	E ₁	N/A
Supply Voltage	At the Limits Specified by the Manufacturer	E ₂	2.7%
Temperature	0°C and 35°C	E ₃	1.04%
Absorbed Current of Device on Test	Maximum Absorbed Current of the Device on Test	E ₄	0.87%
Low-frequency Magnetic Field	Low-frequency Magnetic field 0.4 kA/m	E ₅	N/A
Not Used	Not Used	E ₆	N/A
Capacitance	C _{max} = 1uF	E ₇	N/A
Waveform	R.M.S. CR ≤ 2	E ₈	0.79%
Operating Error	$B=A+1.15\sqrt{E_1^2+E_2^2+E_3^2+E_4^2+E_5^2+E_6^2+E_7^2+E_8^2}$		13.59%

Voltage			
Intrinsic Error or Influence Quantity	Reference Conditions or Rated Operating Conditions	Code	Max Error Seen
Intrinsic Error	Reference Conditions	A	2%
Position	Reference Positions $\pm 90^\circ$	E ₁	N/A
Supply Voltage	At the Limits Specified by the Manufacturer	E ₂	0.5%
Temperature	0°C and 35°C	E ₃	1%
Absorbed Current of Device on Test	Maximum Absorbed Current of the Device on Test	E ₄	N/A
Low-frequency Magnetic Field	Low-frequency Magnetic field 0.4 kA/m	E ₅	N/A
Not Used	Not Used	E ₆	N/A
Capacitance	C _{max} = 1uF	E ₇	N/A
Waveform	R.M.S. CR ≤ 2	E ₈	N/A
Operating Error	$B=A+1.15\sqrt{E_1^2+E_2^2+E_3^2+E_4^2+E_5^2+E_6^2+E_7^2+E_8^2}$		3.29%

Temperature			
Intrinsic Error or Influence Quantity	Reference Conditions or Rated Operating Conditions	Code	Max Error Seen
Intrinsic Error	Reference Conditions	A	5%
Position	Reference Positions $\pm 90^\circ$	E ₁	N/A
Supply Voltage	At the Limits Specified by the Manufacturer	E ₂	0.75%
Temperature	0°C and 35°C	E ₃	1.4%
Absorbed Current of Device on Test	Maximum Absorbed Current of the Device on Test	E ₄	N/A
Low-frequency Magnetic Field	Low-frequency Magnetic field 0.4 kA/m	E ₅	N/A
Not Used	Not Used	E ₆	N/A
Capacitance	C _{max} = 1uF	E ₇	N/A
Waveform	R.M.S. CR ≤ 2	E ₈	N/A
Operating Error	$B=A+1.15\sqrt{E_1^2+E_2^2+E_3^2+E_4^2+E_5^2+E_6^2+E_7^2+E_8^2}$		6.83%

RCD			
Intrinsic Error or Influence Quantity	Reference Conditions or Rated Operating Conditions	Code	Max Error Seen
Intrinsic Error	Reference Conditions	A	10%
Position	Reference Positions $\pm 90^\circ$	E ₁	N/A
Supply Voltage	At the Limits Specified by the Manufacturer	E ₂	1%
Temperature	0°C and 35°C	E ₃	0.41%
Absorbed Current of Device on Test	Maximum Absorbed Current of the Device on Test	E ₄	N/A
Low-frequency Magnetic Field	Low-frequency Magnetic field 0.4 kA/m	E ₅	N/A
Not Used	Not Used	E ₆	N/A
Capacitance	C _{max} = 1uF	E ₇	N/A
Waveform	R.M.S. CR ≤ 2	E ₈	N/A
Operating Error	$B=A+1.15\sqrt{E_1^2+E_2^2+E_3^2+E_4^2+E_5^2+E_6^2+E_7^2+E_8^2}$		11.24%

Appendix 2**PrimeTest 200 Diagnostic Indications****Mains Supply Icons**

PE	PN	NE	
Flash	Flash	Off	The mains supply is too high, too low or not present. These icons can also indicate a fault on RLY1 or RLY2.
Flash	On	Flash	Earth Open - Circuit
On	Flash	Flash	Neutral Open - Circuit

Err 1

The PrimeTest 200 has failed one of the Earth Relay Pre-Check tests. Contact your local service agent.

Err 2

The PrimeTest 200 has failed one of the Safety Relay Pre-Check tests. Contact you local service agent.

Err 3

The PrimeTest 200 has failed an Internal Relay Pre-Check test. Contact your local service agent.

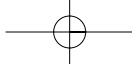

PrimeTest 200

Operating Instructions

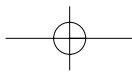
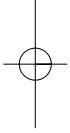
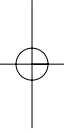

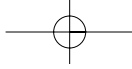

PrimeTest 200

Operating Instructions

